

BRITESTREAM

MULTICOLOURED SLIM90 FIBREGLASS LED LIGHT



The Britestream Slim90 Multicoloured Fibreglass LED light has been specifically designed for easy installation into fibreglass pools & spas.









Britestream Slim90 Fibreglass LED lights are great for those hard to light areas of a pool/spa or steps.

Britestream LED Lights utilise energy efficient super bright LED's and operates on only 15 watts of energy.

- Flush mounted with a minimal 14mm projection into pool.
- Super bright LED's.
- Life span of over 70,000 hours.
- 180° Zonal illumination.
- Operates on only 15% of the electrical power of a halogen light models.



The Britestream Multicoloured Slim90 LED light is cleverly designed with a built in colour memory, which means the light's multicoloured LED's always defaults to its last colour selection. Nine different colour programs are available:

SWITCH SEQ NO	COLOURS & MODES SELECTION	
1	WHITE	
2	SLOW CHANGING COLOURS - 20 SECOND RAMPING	
3	FAST CHANGING COLOURS - 5 SECOND RAMPING	
4	BLUE	
5	MAGENTA	
6	RED	
7	YELLOW - GREEN (GOLD)	
8	GREEN	
9	AQUA	

Technical Specifications

Zonal Distribution	Power Usage	Input Voltage	LED Life
0 to 180 degrees	15Watt	12V AC	70,000 hours

Dimension

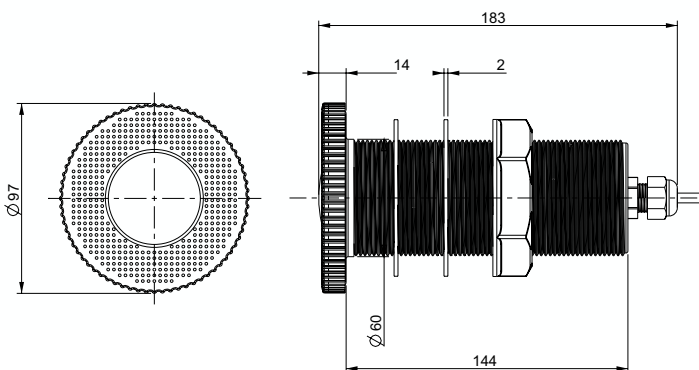

Warranty

Britestream Multicoloured Slim90 LED lights are covered by a comprehensive 2 year warranty.

OFFICES - AUSTRALIA
 NSW - Sydney (Head Office)
 Tel: +61 2 9898 8600
 QLD - Brisbane
 Tel: +61 7 3299 9900
 VIC/TAS - Melbourne
 Tel: +61 3 9764 1211
 WA - Perth
 Tel: +61 8 9273 1900
 SA/NT - Adelaide
 Tel: +61 8 8244 6000
 ACT Distribution
 Tel: +61 2 6280 6476

OFFICES - OVERSEAS
 Waterco (Europe) Limited
 Sittingbourne, Kent, UK
 Tel: +44 (0) 1795 521 733
 Waterco (USA) Inc
 Augusta, Georgia, USA
 Tel: +1 706 793 7291
 Waterco Canada
 Longueuil, Quebec, Canada
 Tel: +1 450 748 1421
 Waterco (NZ) Limited
 Auckland, New Zealand
 Tel: +64 9 525 7570

Waterco (C) Limited
 Guangzhou, China
 Tel: +86 20 3222 2180
 Waterco (Far East) Sdn Bhd
 Selangor, Malaysia
 Tel: +60 3 6145 6000
 PT Waterco Indonesia
 Jakarta, Indonesia
 Tel: +62 21 4585 1481
 Waterco Singapore Int'l Pte Ltd
 Nehsons Building, Singapore
 Tel: +65 6344 2378

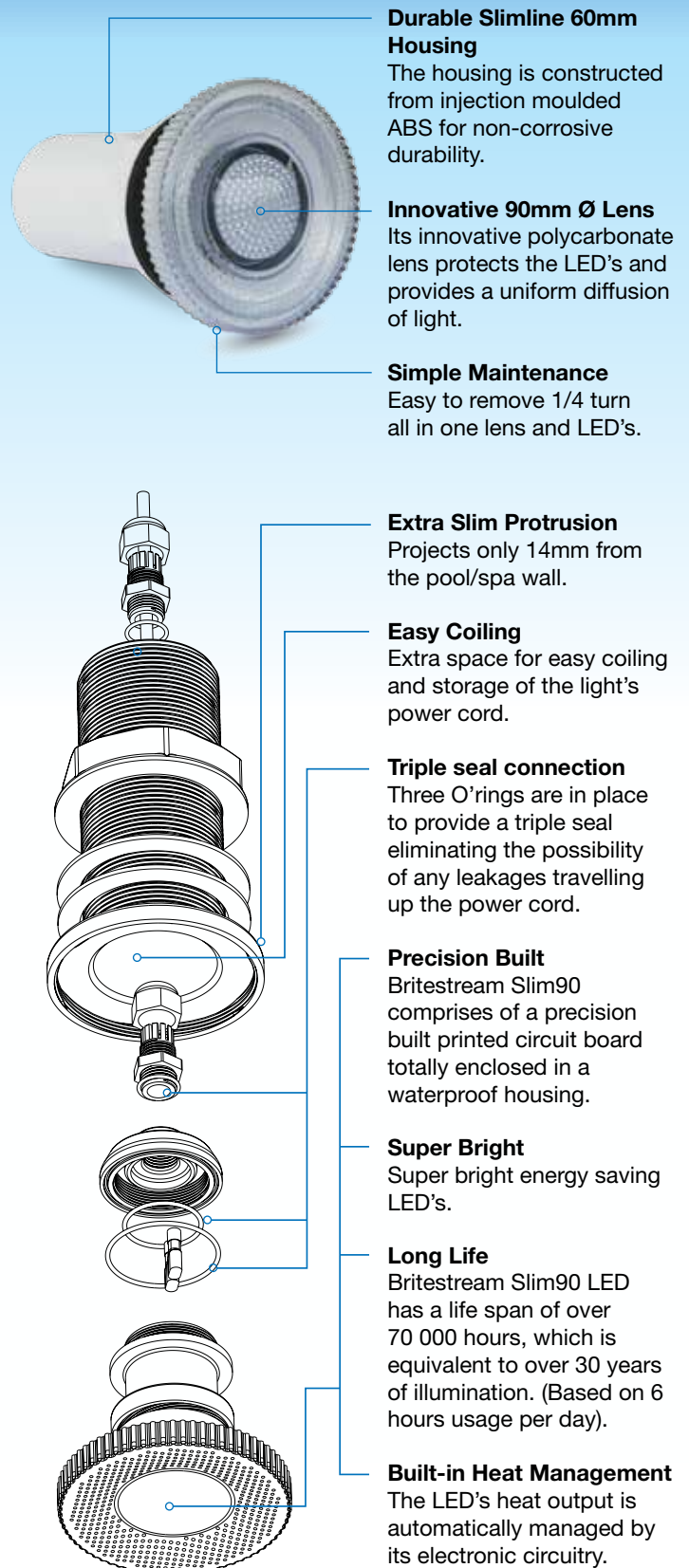

Durable Slimline 60mm Housing

The housing is constructed from injection moulded ABS for non-corrosive durability.

Innovative 90mm Ø Lens

Its innovative polycarbonate lens protects the LED's and provides a uniform diffusion of light.

Simple Maintenance

Easy to remove 1/4 turn all in one lens and LED's.

Extra Slim Protrusion

Projects only 14mm from the pool/spa wall.

Easy Coiling

Extra space for easy coiling and storage of the light's power cord.

Triple seal connection

Three O'rings are in place to provide a triple seal eliminating the possibility of any leakages travelling up the power cord.

Precision Built

Britestream Slim90 comprises of a precision built printed circuit board totally enclosed in a waterproof housing.

Super Bright

Super bright energy saving LED's.

Long Life

Britestream Slim90 LED has a life span of over 70 000 hours, which is equivalent to over 30 years of illumination. (Based on 6 hours usage per day).

Built-in Heat Management

The LED's heat output is automatically managed by its electronic circuitry.

DISTRIBUTED BY:

WATERCO
 water, the liquid of life

